

SPECIFICATION

1. Rated voltage: 300V 15A(CE)
2. Insulation Withstands Voltage: AC2000V/MIN
3. Insulation Resistance: 500MΩ or more at DC500V
4. Using Temperature Range: -40°C/+105°C
5. Screw Torque Value: 0.4N.m
6. Suitable Electric Wire: 28-14AWG
7. Storage condition: room temperature, the humidity below 85%, shelf life: 1 year.
8. Origin: China ningbo cixi

MATERIAL

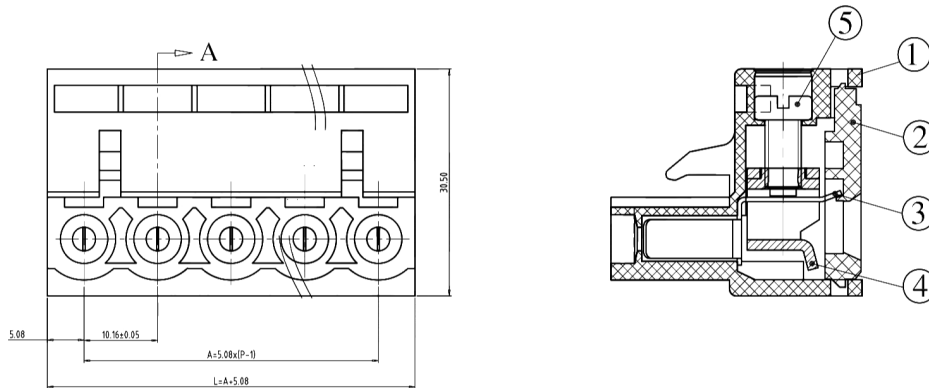

#: Back to the material used ≤ 30%

N.o	NAME	MATERIAL	SPECIFICATIONS
1	HOUSING	PA66(UL94V-0)	GREEN
2	COVER	PA66(UL94V-0)	GREEN
3	CLAMP	BRONZE	EP-Cu/Cu1-2 Ni2-4um
4	BLOCK	STEEL	EP-Fe/Cu1-2 Zn5-8um
5	SCREW	STEEL	M3.0EP-Fe/Cu1-2 Zn5-8um

HOW TO ORDER

插拔式 (母座)

系列码	序列码	特征码	识别码
ZBK	400R	XXP	GS

颜色代号: G-绿色, 标准色可省略细分代号
 线数 (XXP), XX表示不固定线数
 R: 进线方向与针脚水平
 规格分类流水号
 间距代号: 4-5.08mm
 ZB-公司代码, K-插拔式 (公座)

Packing Bag:
Size: 20.0×19.0 (cm)

深圳市金航标电子有限公司	WWW.BDS666.COM
KH-ZBK400R-2P-5.08GS	0755-83044319