

PCB LAYOUT

SPECIFICATIONS

- 1、Current Rating: 3A AC, DC
- 2、Voltage Rating: 250V AC, DC
- 3、Temperatuer Range: -25°C~+85°C
- 4、Contact Resistance: 20mΩ Max
- 5、Insulation Resistance: 1000MΩ Min
- 6、Withstanding Voltang: 800V AC/minute
- 7、Material: Wafer LCP, UL94V-0
PIN Brass Tin-plated

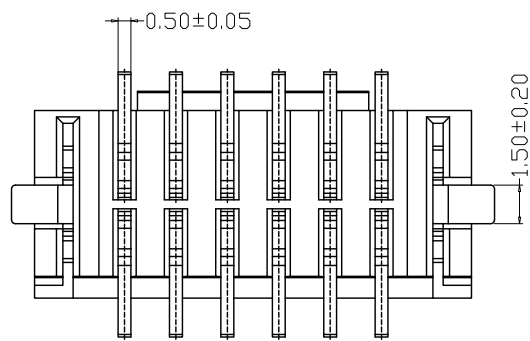
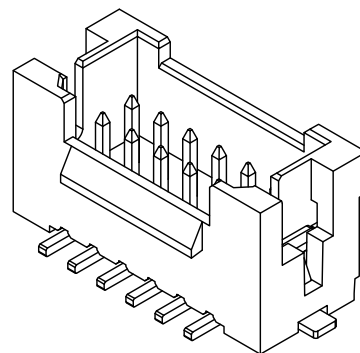
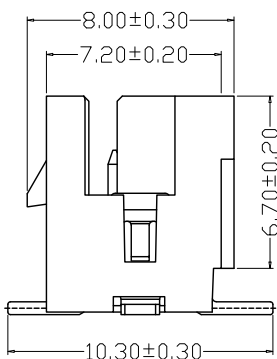
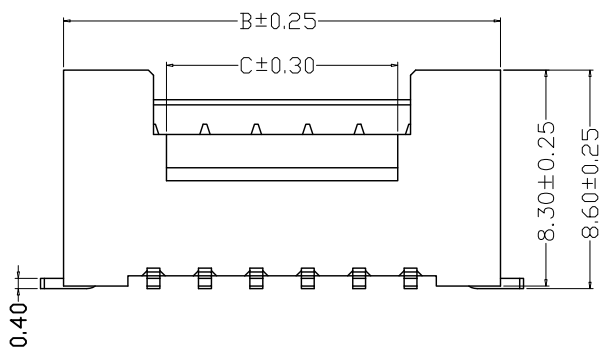

编 号	尺寸 (mm)		
	A	B	C
A2009-2x02AB	2.00	9.00	3.00
A2009-2x03AB	4.00	11.00	3.00
A2009-2x04AB	6.00	13.00	3.00
A2009-2x05AB	8.00	15.00	5.00
A2009-2x06AB	10.00	17.00	7.00
A2009-2x07AB	12.00	19.00	9.00
A2009-2x08AB	14.00	21.00	11.00
A2009-2x09AB	16.00	23.00	13.00
A2009-2x10AB	18.00	25.00	15.00
A2009-2x11AB	20.00	27.00	17.00
A2009-2x12AB	22.00	29.00	19.00
A2009-2x13AB	24.00	31.00	21.00
A2009-2x14AB	26.00	33.00	23.00
A2009-2x18AB	34.00	41.00	31.00
A2009-2x20AB	38.00	45.00	35.00

制图 DRAWN	变更内容 DESCRIPTION	日期 DATE	GENERAL TOLERANCE		制图 DRAWING	钱岳生 2022、05、15		料号 PART NO.	A2009-2*nAB		版本 REV.	A
			X.±0.25	X.*±2'	审核 CHECK	潘云丹 2022、05、16		品名 TITLE	PHB双头带焊片立贴 WAFER SMT TYPE		页次 SHEET	1/1
			.XX±0.20	.X'±1'	核准 APPROVAL	张名 2022、05、16		客户料号 CUTM. NO.				
			.XX±0.15	.XX'±0.5'	单位 UNITS	MM	比例 SCALE	1:1	深圳市金航标电子有限公司		www.kinghelm.com.cn	
			.XXX±0.10	.XXX'±0.5'			KH-A2009-2X08AB		0755-28190160			