

Product specification

Drawing No. : KH-2FK1-B-SM-101

Series description

FAKRA connectors are designed to perform up to 6 GHz and meet the particular mechanical and environmental requirements of the automobile industry. This connector is designed to meet or exceed the requirement of specification for automotive RF connector systems. Interface is designed to meet DIN 72594-1 and automotive electrical & RF connector systems meet SAE/USCAR-2 & SAE/USCAR-17 performance specification.

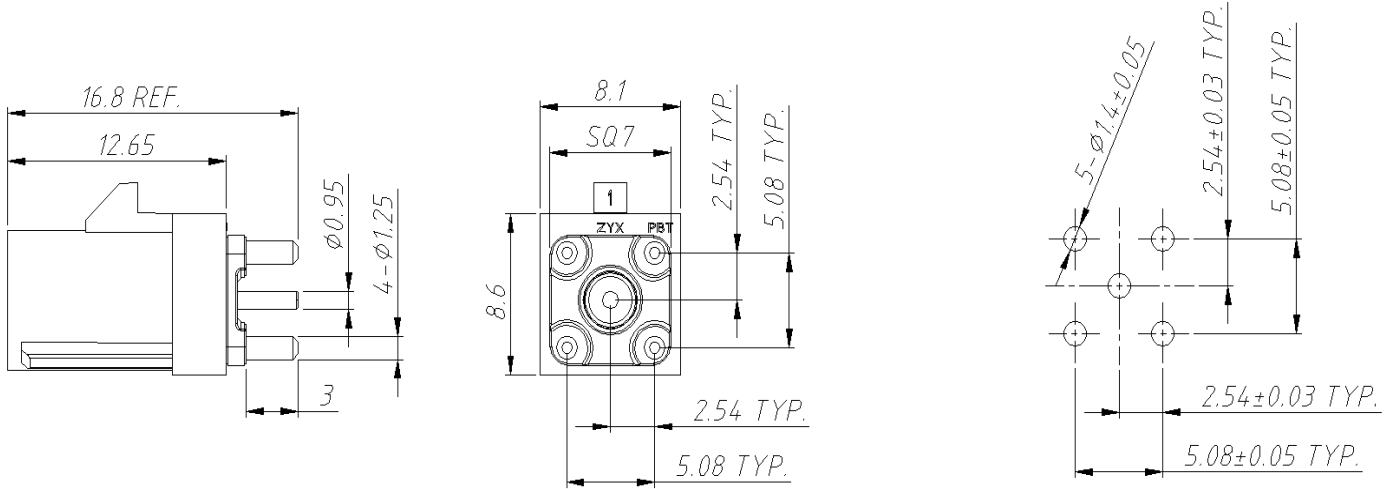

RECOMMENDED PCB LAYOUT

Electrical data

- | | |
|--|---|
| 1) Impedance | 50 Ω, Nominal |
| 2) Frequency range | DC-6 GHz |
| 3) VSWR(Return loss) | DC-2 GHz ≤ 1.4 (15.56 dB)
2-3 GHz ≤ 1.5 (13.98 dB)
3-6 GHz ≤ 1.6 (12.74 dB) |
| 4) Dielectric withstanding voltage | 800 V rms, Min. |
| 5) Insulation resistance | ≥ 100 MΩ |
| 6) Contact resistance | |
| Original state | ≤ 10 mΩ |
| After endurance or environmental tests | ≤ 40 mΩ |

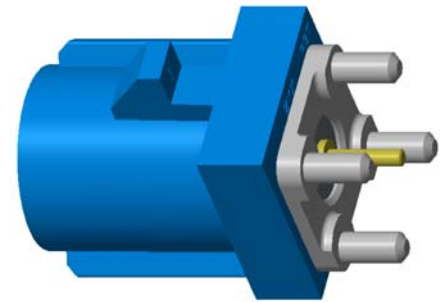

Mechanical data

- | | |
|----------------------------|----------------|
| 1) Outline dimensions | Per Drawing |
| 2) Durability | 25 Cycles Min. |
| 3) Meet USCAR-2 & USCAR-17 | |

Material and finish

Component description	Material	Finish
1) Housing	PBT	Per key code
2) Body	Zinc alloy	Nickel plating
3) Insulator	PTFE	Natural
4) Contact pin	Brass	Au plating

深圳市金航标电子有限公司		TITLE		DATE	
		FAKRA PCB VT PLUG		2020-7-2	
				CREATED	
				ERIC	
				CHECKED	
				FANCY	
ECN		P/N		APPROVED	
		KH-2FK1-B-SM-101		JASON	
DATE		SHEET		REV.	
		1 OF 2		A1	

Product specification

Drawing No. : KH-2FK1-B-SM-101





Environmental data

1) Temperature range	-40 °C To 105 °C	
2) RoHS compliant	Yes	
3) Thermal shock	USCAR-17, Paragraph 4.5.1	-40 °C To 85 °C, 100 Cycles
4) Vibration & Mechanical shock	USCAR-2, Paragraph 5.4.6	Random, 5-10 ms, 35Gs, 1/2 sine
5) Temperature/Humidity cycling	USCAR-2, Paragraph 5.6.2	40 Cycles, 8 Hours/Cycle

Other

2FK1-X-SM-101: "X" Show key code
 Key code see: FK-PLUG-KCX

Key code

KEY CODE	PART NO.	COLOR	RAL
 A	2FK1-A-SM-101	JET BLACK	9005
 B	2FK1-B-SM-101	CREAM WHITE	9001
 C	2FK1-C-SM-101	SIGNAL BLUE	5005
 D	2FK1-D-SM-101	CLARET VIOLET	4004
 E	2FK1-E-SM-101	LEAF GREEN	6002
 F	2FK1-F-SM-101	NUT BROWN	8011
 G	2FK1-G-SM-101	BLUE GREY	7031
 H	2FK1-H-SM-101	HEATHER VIOLET	4003
 I	2FK1-I-SM-101	BEIGE	1001
 K	2FK1-K-SM-101	CURRY	1027
 L	2FK1-L-SM-101	CARMIN RED	3002
 M	2FK1-M-SM-101	PASTEL ORANGE	2003
 N	2FK1-N-SM-101	PASTEL GREEN	6019
 Z	2FK1-Z-SM-101	WATER BLUE	5021

深圳市金航标电子有限公司		TITLE		DATE	2020-7-2
		FAKRA PCB VT PLUG		CREATED	ERIC
ECO				CHECKED	FANCY
ECN		P/N	KH-2FK1-B-SM-101	APPROVED	JASON
DATE		SHEET	2 OF 2	REV.	A1