

PIN NUMBER	SIGNAL NAME
PIN 1	Vbus
PIN 2	D-
PIN 3	D+
PIN 4	GND
PIN 5	StdA_SSRX-
PIN 6	StdA_SSRX+
PIN 7	GND_DRAIN
PIN 8	StdA_SSTX-
PIN 9	StdA_SSTX+
SHELL	GND

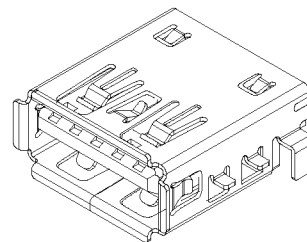
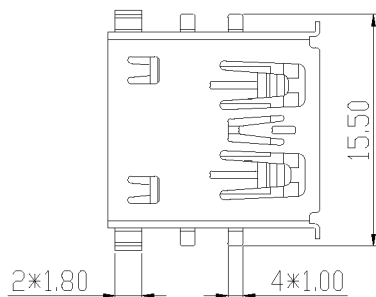

3D VIEW

NOTES:

- MATERIAL:
  - HOUSING: LCP ,COLOR IS BLUE,HIGH TEMPERATURE PLASTIC;
  - CONTACT: BRASS (H65 T=0.20mm);
  - SHELL: COLD ROLLED IRON (SPCC T=0.30mm);
- ELECTRICAL:
  - VOLTAGE RATING: 30V DC ;
  - CURRENT RATING: 1.5A ;
  - CONTACT RESISTANCE: 30MILLIOHMS MAX.;
  - WITHSTAND VOLTAGE: 100V AC RMS 50(60)Hz,1MIN.;
  - INSULATION RESISTANCE: 100MEGOHMS MIN @500V DC;
- MECHANICAL:
  - MATING FORCE: 35N MAX.;
  - UNMATING FORCE: 5~35N ;
  - OPERATING LIFE: 1500 CYCLES MIN.;
- PLATING:
  - TERMINAL:  
 NI PLATING OVER ALL,  
 Tin PLATING ON SOLDER AREA,  
 Au G/Fu ON CONTACT AREA;
  - SHELL: NI PLATING OVER ALL;
- ENVIRONMENTAL:
  - STORAGE TEMPERATURE RANGE: -40°C~+85°C;
  - OPERATION TEMPERATURE RANGE: -25°C~+70°C;

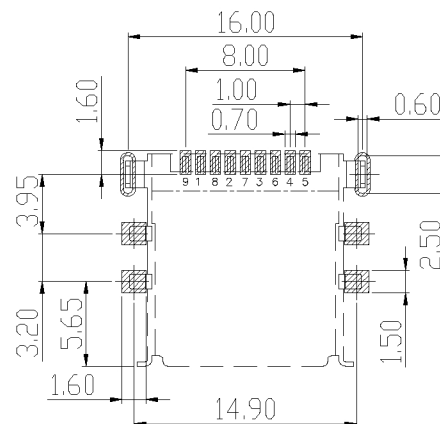
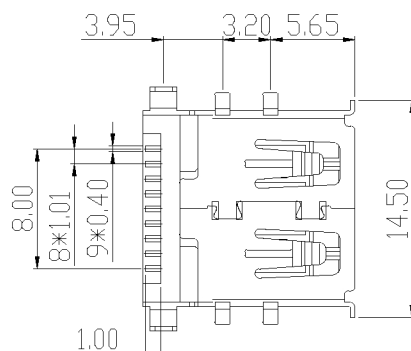
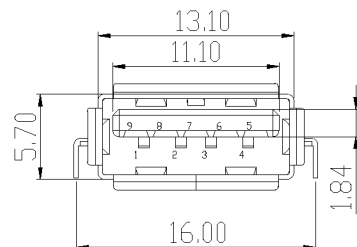
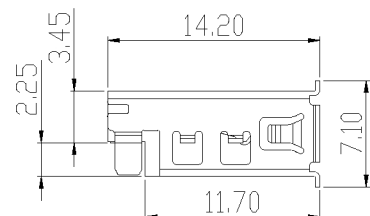
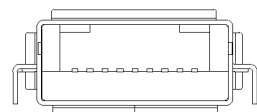

RECOMMEND PCB LAYOUT(±0.05)

深圳市金航标电子有限公司		www.kinghelm.com.cn		
KH-3.0AF90CB-14.2JB-SMT		0755-28190160		
UNLESS OTHERWISE SPECIFIED:		NAME:		P/N: 09.03.02.076
GENERAL TOLERANCE:		DWG NO.:		
X.xxx ±0.10		3.0 A母沉板直脚卷边B款		
X.xx ±0.20				
X.x ±0.30				
ANGULAR:		THIRD ANGLE PROJECTION	UNIT: mm	SCALE: 1:1
X.xx° ±1°			SIZE: A4	SHEET: 1/1
X.x° ±3°			REV.: A1	
X.° ±5°		DRAWN:		CHECKED:
		APPROVED		