

版次	变更摘要	日期
0	新产品发行	2015/1/28
1	配合改善胶芯缺料, 胶芯加胶	2019/9/22

序号	品名	材质
①	0.5拉拔胶芯 (H1.2)	LCP UL94V-0 本色
②	0.5拉拔上接端子 (H1.2)	表面镀锡
③	0.5拉拔后盖 (H1.2)	LCP UL94V-0 黑色
④	0.5拉拔焊片 (H1.2)	表面镀锡

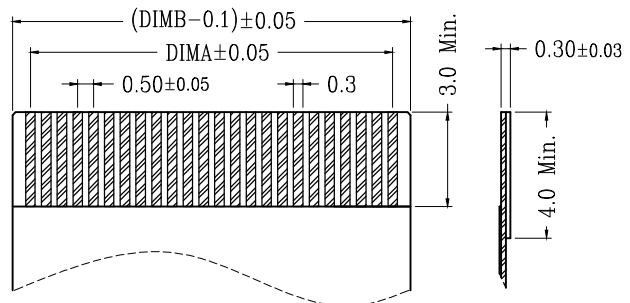

适用扁平线 (Applicable Flat Cable)

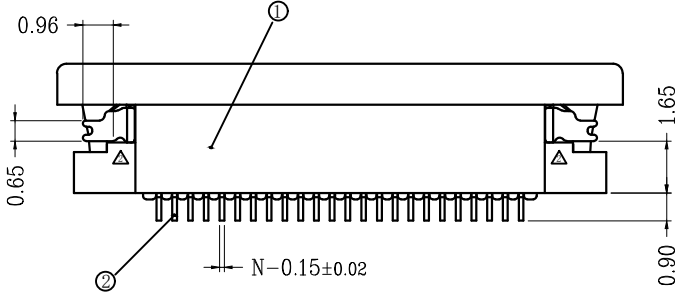
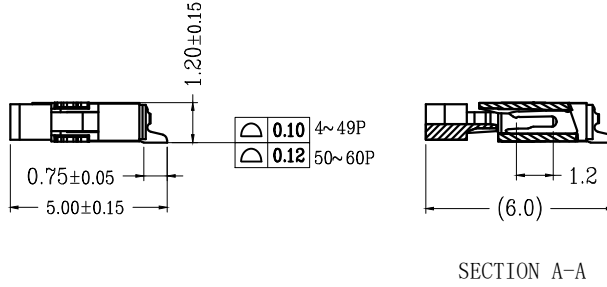
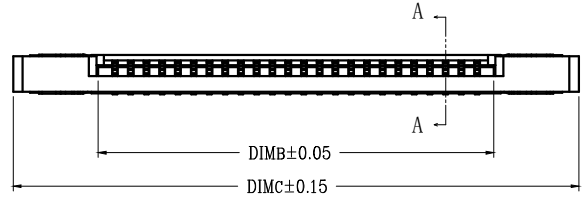
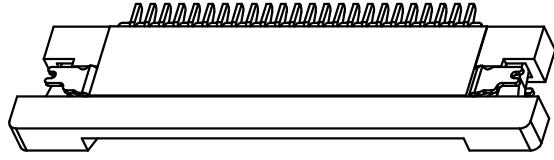
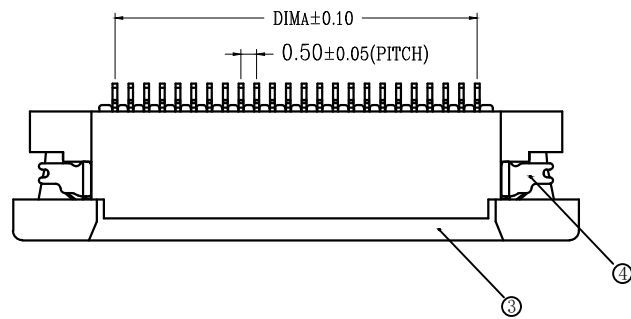
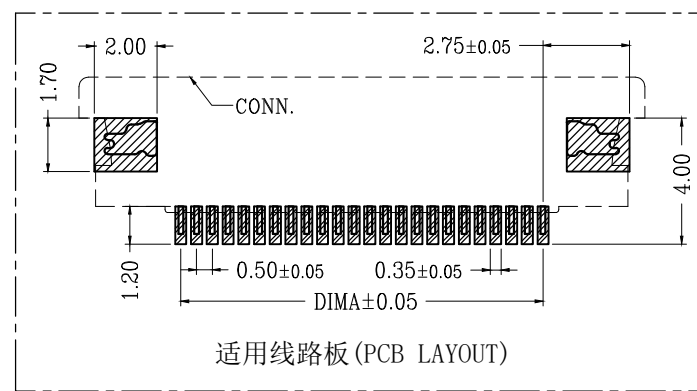

适用线路板 (PCB LAYOUT)

CKT	DIM A	DIM B	DIM C	CKT	DIM A	DIM B	DIM C
4	1.50	2.56	7.96	33	16.00	17.06	22.46
5	2.00	3.06	8.46	34	16.50	17.56	22.96
6	2.50	3.56	8.96	35	17.00	18.06	23.46
7	3.00	4.06	9.46	36	17.50	18.56	23.96
8	3.50	4.56	9.96	37	18.00	19.06	24.46
9	4.00	5.06	10.46	38	18.50	19.56	24.96
10	4.50	5.56	10.96	39	19.00	20.06	25.46
11	5.00	6.06	11.46	40	19.50	20.56	25.96
12	5.50	6.56	11.96	41	20.00	21.06	26.46
13	6.00	7.06	12.46	42	20.50	21.56	26.96
14	6.50	7.56	12.96	43	21.00	22.06	27.46
15	7.00	8.06	13.46	44	21.50	22.56	27.96
16	7.50	8.56	13.96	45	22.00	23.06	28.46
17	8.00	9.06	14.46	46	22.50	23.56	28.96
18	8.50	9.56	14.96	47	23.00	24.06	29.46
19	9.00	10.06	15.46	48	23.50	24.56	29.96
20	9.50	10.56	15.96	49	24.00	25.06	30.46
21	10.00	11.06	16.46	50	24.50	25.56	30.96
22	10.50	11.56	16.96	51	25.00	26.06	31.46
23	11.00	12.06	17.46	52	25.50	26.56	31.96
24	11.50	12.56	17.96	53	26.00	27.06	32.46
25	12.00	13.06	18.46	54	26.50	27.56	32.96
26	12.50	13.56	18.96	55	27.00	28.06	33.46
27	13.00	14.06	19.46	56	27.50	28.56	33.96
28	13.50	14.56	19.96	57	28.00	29.06	34.46
29	14.00	15.06	20.46	58	28.50	29.56	34.96
30	14.50	15.56	20.96	59	29.00	30.06	35.46
31	15.00	16.06	21.46	60	29.50	30.56	35.96
32	15.50	16.56	21.96				

技术指标:

1. 塑件表面应光洁、无毛边、无明显收缩、缺陷、裂纹等现象。
2. 温度范围: -25° C~85° C.
3. 额定电压: 50V, AC/DC(等效)。
4. 接触电阻: ≤0.03Ω.
5. 绝缘电阻: ≥500MΩ
6. 电镀方式 :端子全雾锡



一般公差 (TOLERANCE)  
 X ±0.50 XX ±1.0  
 X ±0.20 XXX ±0.05  
 ANGLES ±1°

深圳市金航标电子有限公司		www.kinghelm.com.cn	
KH-CLO.5-H1.2-30PS-SMT		0755-28190160	
品名 (TITLE)	0.5 Pitch拉拔卧式上接 (H=1.2)		制图 (DR) Anlan
料号 (DWG.NO)	KH-CLO.5-H1.2-30PS-SMT		校对 (CHKD) 李绍宗
比例 (SCALE)	1:1	单位 (UNITS) mm	审核 (APPD) 黄志明
张数 (SHEET)	1 OF 1	尺寸 (SIZE) A4	REV A